

Interactive High Speed Option

Constraints Driven Design Rules

Pulsonix delivers a powerful set of constraint rules-driven interactive High Speed design features. Conceived from the Schematic, the design is defined by the engineer during the early logical capture phase. All constraint rules are passed to the PCB design where they are implemented using graphical guidance to ensure the layout is correct first time.

Rules Spreadsheet

As you design, the Rules Spreadsheet browser window dynamically displays critical tracking along with its constraints. The display can be fully customised to show rules of interest currently during track editing using user-defined filters. This information is dynamic and updated in real time, keeping you informed at all times. The results from the Rules Spreadsheet can be exported to a CSV format for further analysis or documentation.

Rules Spreadsheet								
Differential Pairs								
Name	Diff Pair Link	Net1	Pad11	Pad12	Net2	Pad21	Pad22	Pair Skew
J1-U8 (1)			J1.112	U8.D3		J1.111	U8.C3	-0.859+
J1-U9 (2)			J1.101	U9.C3		J1.102	U9.D3	0.796-
	J1.101-RN33.1 J	RDQS6B	J1.101	RN33.1	RDQS6	J1.102	RN33.2	0.000
	RN33.4-Branch3	DQS6B	RN33.4	Branch3	DQS6	RN33.3	Branch4	0.849-
	Branch4-U9.C3	DQS6	Branch4	U9.C3	DQS6B	Branch3	U9.D3	0.000
J1-U10 (2)			J1.101	U10.D3		J1.102	U10.C3	0.878+
J1-U17 (1)			J1.112	U17.D3		J1.111	U17.C3	-0.859+

Customise the Rules Spreadsheet to display rules important to you

Serpentine Routing

Serpentine Routing enables you to accurately increase the precise length of high speed nets following your constraint rules without introducing errors using the visual references. From within the Serpentine Routing rules dialog, you can define additional constraint parameters, such as the serpentine shape, minimum/maximum amplitude, separation of each loop and the number of loop cycles to insert.

The dynamic serpentine routing tool allows serpentes to be created on the fly, adhering to the rules defined and with visual references to the rule parameters and a dynamic head-up display.

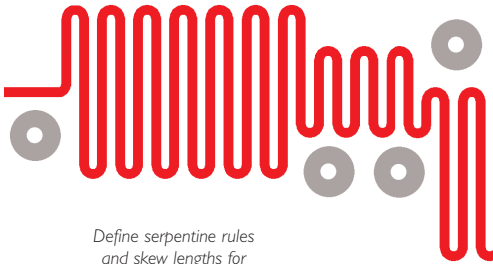

Define serpentine rules and skew lengths for differential pairs

Differential Pair Routing

The advanced constraint rules allow Differential Pairs to be created easily and quickly. The two net pairs are routed interactively from their source using a dual path for both tracks and utilising an optional spacing rule between them to keep separation precise. Rules can be defined to length match pairs against other pairs. When layer swaps are required, you can choose the via pattern to use. The interactive editor displays the legal via pattern available and the new track exit paths. Used in combination with the other Net Length rules, precise control of the length of the Differential Pairs can also be created. Once routed, inherent Differential Pair knowledge is retained so that track 'pair' still acts as one entity, making modification less error prone. These rules also form part of the post-layout Design Rule Checking.

Individual length skew for each track within a differential pair can be defined and added using the skew rules and serpentine routing tool.

Where multiple Differential Pairs are sequenced together, Pulsonix can consider these as 'chains' and not only create a unique identity for these, but also fully identify a path for them from source to target so that a totally inclusive path length is defined. This even includes a path length through series components that have their own defined length, such is the accuracy of Pulsonix.

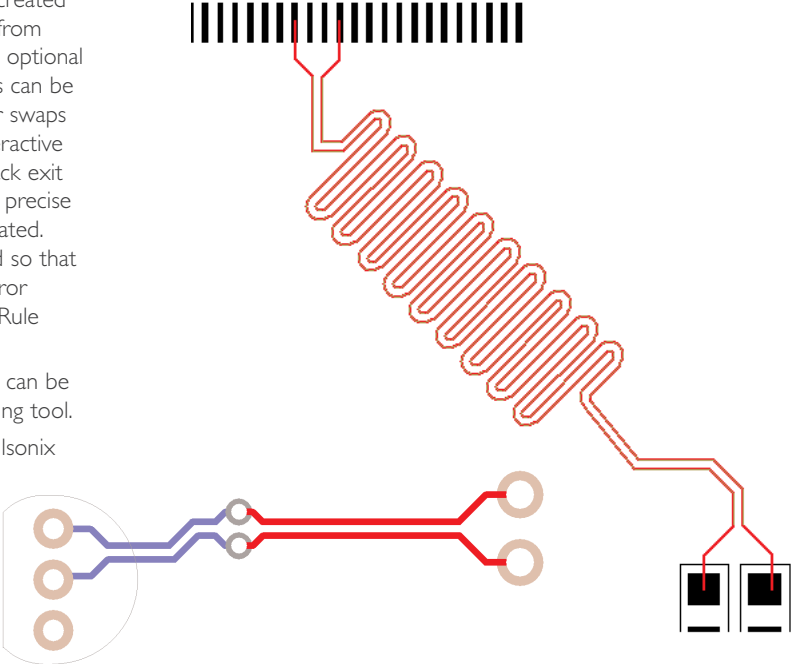

Interactive High Speed Option



Interactive Length Indicators

During track routing, the interactive display shows a graphical representation of the rules by displaying dynamic shapes around the area to be routed indicating whether the track is within the minimum or maximum rule limits defined. Additionally, colour coded and text-based head-up display show whether you are working within the constraint rules. This display at the end of your cursor as well as the Rules Spreadsheet makes high speed designing breeze in Pulsonix.

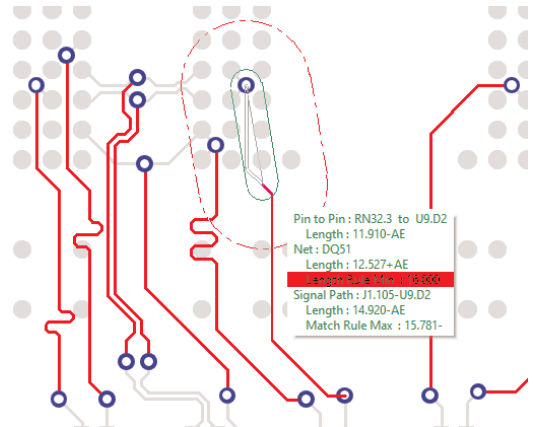

A 'head-up' display shows you colour-coded rules as the design is edited and the track lengths change

Layer Change Length

Where a change of layer is critical in terms of a via length through the board, a layer change length rule can be created to add the layer span thickness to the overall track length. This is considered and reported in all aspects of the design when editing and reporting the track length.

Attribute: <Net Class Name>

Match: HS

From Layer: Top

To Layer: Bottom

Applies To: Pads Vias

Easily create layer change rules displayed using a graphical representation

Track Length Matching

Where length matching is required across groups or collections of net items, powerful rules can be set up to accommodate this. Rules can be set for all net items and net attribute values within the design. This means even nets with dissimilar names can be effectively grouped or categorised with the same rule applied to them.

Where the max length difference requires a design change, within the Rules Spreadsheet, a net based item can be defined as the override length matched target where this then becomes the new 'match' target. This provides you with total flexibility to achieve the design required.

Attribute Name	Match Value	Extra Delay Length	Max Length Difference
<Differential Pair Name>	DQ*	0.00000	3.81000
<Net Name>	HS*	0.00000	12.70000
<Net Class Name>	HSE	0.00000	2.00000
<Net Class Name>	PAIR	0.00000	6.35000

Attribute: <Net Name>

Match: HS*

Create powerful rules with to accurately define your signal paths

Necked Length Rule

The necked length rule allows you to define a rule for use where the length of the track necking over a distance must fall within minimum and maximum ranges. As well as the actual necked length, the maximum necked width can also be defined. A post-design check ensures the track thickness hasn't been overridden under the critical defined value.

Track Length Rules

Where critical length is required, Pulsonix allows you to create rules to cover net items using minimum and maximum parameters. These can be defined over the total track length or a maximum pin to pin track length. As is the flexibility of the rules, you can add rules to cover all rules for the same net items.

Using the Track Length Factor rules dialog, define a rule for specific nets or track paths where a defined signal must 'arrive' at a target point earlier or later than other defined signals.

Attribute Name	Match Value	Extra Delay Length	Max Length Difference
Length Match	RDQ48-59	0.000	1.000
<Signal Path Name>	*Branch*	0.000	0.500
Length Match	J1[U6,9,10,17]	0.000	1.000
<Net Name>	DM6	0.000	1.100
	DM7	2.000	

Attribute: <Net Name>

Match: DM6

Extra Match: DM7

Rules details enable precise control of net-based items

Parallel Segment Rules

Parallel segment rules can be created where net spacing and length is important to reduce crosstalk. The rules can be created for any net-based item for the same layer or adjacent layers. Different rules can be defined for the same net item either on the same and/or adjacent layers.

Pin Package Rules

Add extra length to a pin or package where critical length is particularly an issue. The 'internals' length delays of a package can be determined from the manufacturers datasheet.

Interactive High Speed Option



Daisy Chain Routing

Sub Net rules allow you to define portions of a net where specific track sequences are required. Sequencing is easily created in the Sub Nets dialog using point and click operation or simple selection and pick from list. Once defined, these rules are always used during routing and can be further checked using the DRC Manufacturing feature.

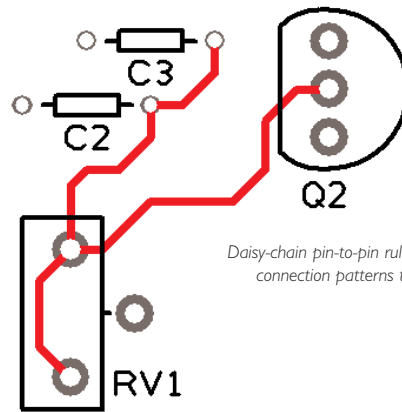

Daisy-chain pin-to-pin rules enable precise connection patterns to be created

RF Design features

The High Speed option contains RF design features, these include advanced Spiral for the creation of spiral copper, tracks and shapes. These can be used on electrical and non-electrical layers as required. When created as tracks or copper, they can also be connected to as part of a net. Full DRC checking to these items is also permitted. Spirals can be associated with pads and vias within a footprint and reused on multiple designs. Complex spirals can also be used to create components such as planar transformers for use through multi-layer and Embedded Component technologies.

As part of the RF design suite, Pulsonix provides essential features to facilitate square-ended tracks and chamfered track corners. Both features are controlled using the RF Track Rules dialog which defines the net item and its parameters. Square-ended tracks provide precise track ends when an 'open-ended' square end is required without the use of a square landing pad to achieve this. Chamfered corners allow a traditional 45-degree external corner but an internal mitre containing a 90-degree corner, ideal for RF designs. These are of course, in addition to a curved or filleted corner that can be created for RF tracks.

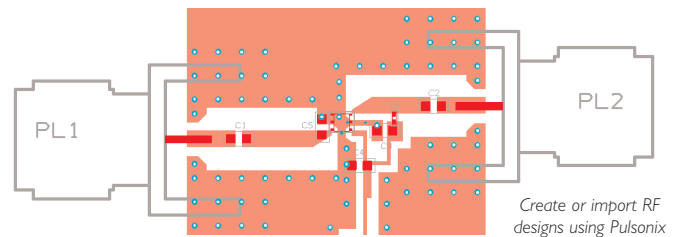

Create or import RF designs using Pulsonix

Chamfered corners provide 45 degree 'outside' and 90 degree 'inside' edges

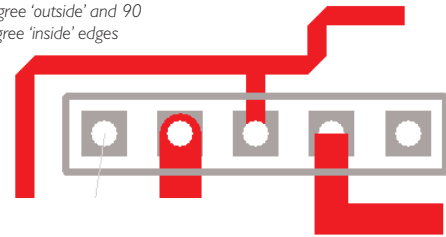

Square-ended tracks provide precise track ends when an 'open-ended' square end is required

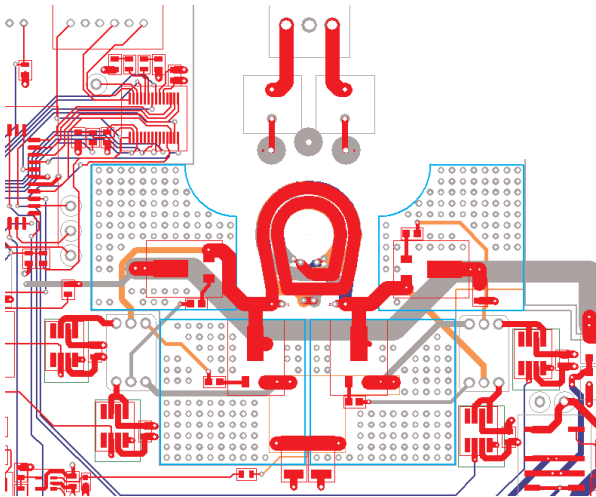

Define spirals for planar transformers spanning multiple layers

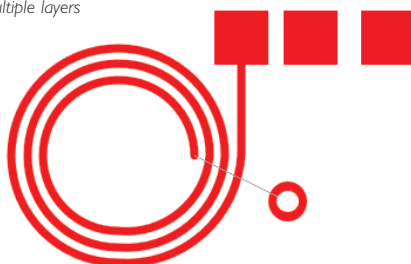

Pulsonix High Speed Feature & Rules Summary:

- Easily defined constraint management
- Differential Pair definition and routing of pairs
- Differential Pair chain rules
- Pattern control for Differential Pair vias
- Differential Pair track skew rules
- Dynamic head-up display
- Graphical net length indicators
- Track length rules
- Sub net feature Daisy chain Pin-to-Pin topology rules
- Automatic and dynamic serpentine routing
- Parallel Tracks rules
- Necked Track rules
- Track Length Match rules
- Track Length Factor rules
- Spiral creation using intelligent rules
- Circular/square spiral shape creation
- Square-ended tracks
- Chamfered track corners for true RF mitres